



DELTA

Two-Way Radio



DS 580

INSTRUCTION MANUAL

Thanks

Thank you for choosing **DELTA** DMR Digital Radio, we believe it is a wise choice to choose us because we have the latest technology, the most stable components, the most advanced production technology. **DELTA** radio will provide you with the reliable performance and high quality you demand.

This user manual apply to: DELTA DS580



Safety Instruction

Please observe the following safety tips to prevent fire, accidents, personal injury or equipment damage.

- ▶ **Do not** modify the radio or its charger in any way.
- ▶ **Do not** expose the radio to direct sunlight for extended periods of time, leave near heaters or other heat sources.
- ▶ **Do not** store or use unprotected radios for prolonged periods in areas of high dust or excessive moisture.
- ▶ Users may experience signal interference if the unit is used near devices such as TV or electric generators.
- ▶ If the unit emits smoke or you notice a strange smell, immediately turn off the power, and send it to the closest repair service station.
- ▶ The radios are small but contain high power components. It is not uncommon to notice slight warming of the handset. This is normal and the unit may continue to be used.

If there is any problem with the unit, please contact DELTA or your local distributor.

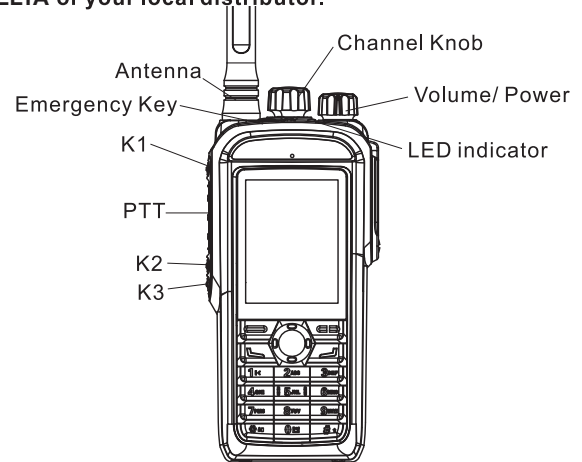

Turn on

Turn the Volume/Power knob clockwise to turn the radio on.
(Some radios are programmed to emit a tone when powered on).

Turn off

Turn the Volume/Power knob counter clockwise to turn the radio off, you will hear a sound when the radio is turning off.

Volume adjustment

Press and hold down the squelch key off momentarily to hear the continuous beep and turn the volume/power knob to adjust.

Three way to choose channel

1. Channel knob: rotate around the "channel control" to choose the channel you need.
2. Channel button: choose the channel you need.
3. Input: when the keyboard mode is in the channel mode, you can directly enter the channel number needed.

Transmit and receive

Press the PTT button to enter the transmit state. The Red LED will light.

Release the PTT button to revert back to the receive state, the green LED will light when voice or data are received.

DELTA Radios Quality Warranty and Liability

The warranty range and limitation

DELTA is committed to quality and stands behind its products. DELTA will, during the warranty period specified for each product, repair or replace components that fail as a result of poor workmanship or materials. This warranty does not cover improper use or intentional damage.

The warranty policy does not include the following conditions:

1. Defects or damages caused by working in abnormal or unusual situations.
2. Defect or damages caused by misuse, accident, or water submersion.
3. Defect or damages caused by unauthorized installation, repair, tampering or adjustment.
4. Warranty does not extend to cosmetic scratches or damages as a result of normal use or misuse.
5. This warranty is void if:
 - (a) the product information label on the back aluminum case is removed, or if the serial number is tampered with, changed, or cannot be identified.
 - (b) If the battery case is damaged, tampered with, or unsealed.

General Items

This warranty policy establishes the liability limits for which DELTA is responsible
DELTA has the right to decide, in their sole discretion, whether to repair, replace, or refund the purchase price of any equipment subject to this warranty. There are no other options available under this warranty. This express warranty is the complete agreement. **OTHER THAN AS EXPRESSLY SET OUT IN THESE TERMS OR ADDITIONAL TERMS, NEITHER DELTA NOR ITS SUPPLIERS OR DISTRIBUTORS MAKE ANY SPECIFIC PROMISES ABOUT THE SERVICES OR PRODUCTS.**

CONTENT

Unpacking and device check.....	1
Accessory.....	1
Battery information.....	2
Battery protection.....	2
Battery Usage.....	3
Preparation.....	4
Installing the battery.....	4
Assemble the antenna.....	4
Assemble the belt clip.....	5
Disassemble the belt clip.....	5
Insert the earphone.....	5
Function and basic operation.....	6
Charging the Battery.....	7
Charger Indicator.....	7
LED Indicator of Transceiver.....	8
LCD icon.....	8
Power on and off.....	9
Charger Indicator.....	9
LED Indicator of Transceiver.....	9
Product operation instructions.....	10
Keyboard Introduction.....	10
Working mode.....	10
User Mode.....	12
Safety information.....	25
Caution.....	27
Technical Specification.....	28

Unpacking and device check

Please take the radio out of the package carefully and before disposing of the packing materials, check the accessories according to the following list. If any part is lost or damaged, please submit a claim letter to the carrier or deliver.

Accessories

Items	quantity
Antenna	1
Belt clip	1
Power supplier	1
Battery	1
Charger	1
Lanyard	1
Instruction manual	1
Warranty card	1



Antenna

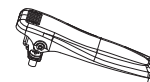

Belt clip



Lanyard

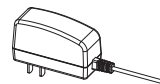

Power supplier



Charger

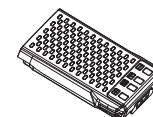

1800mAh
Li-ion battery

Battery information

Battery protection

Delta radios use lightweight, environmentally friendly lithium-ion batteries as a power source.

1. Be sure to use the original Delta charger to charge the battery.
2. When charging radios, please power off the radios to ensure battery can be fully and effectively charged.
3. New, uninstalled batteries can be stored for long period, but should be stored in a cool, dry place. (These should be recharged once every three months to maintain the battery's electrical properties, otherwise it will be damaged and will not function properly).
4. New batteries need to be fully charged before use.
5. Use only the battery charger and power supply specified by DELTA. Use of non-authorized charging systems will void the warranty of both the battery and the equipment.
6. Avoid extreme temperatures as this will effect capacity of the battery.
7. The battery cannot be stored in hot or cold places, otherwise it will reduce battery capacity and useful life. The battery should always be stored at normal temperature, and radios equipped with cold batteries may temporarily not work, even if fully charged.
8. Do not let the metal stripes on the battery come into contact with metal objects (such as metal benches, pins, etc) as this may cause the battery to short circuit.
9. Always dispose of old or damaged batteries In accordance with local recycling laws.
10. **NEVER** discard or expose batteries to fire, this will result explosion and serious injury or death.

Battery Usage

1. Do not use, install or attempt to charge damaged batteries.
2. Do not use batteries in any other equipment other than that which it is designed for.
3. Battery charging time varies and is determined by the remaining capacity of the battery and the battery and charger type. The battery can be repeatedly charged and discharged more than 300 times, but they will age with use. Aging will occur quicker when batteries are used for short periods and then recharged. Batteries should be allowed to fully discharge before charging to prolong battery life.
4. Batteries that are stored and unused will discharge over time.

Preparation

Installing the battery

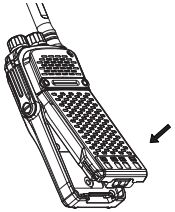

Assemble: Align the battery with the radio chassis, push forward and down until the battery clicks in place.

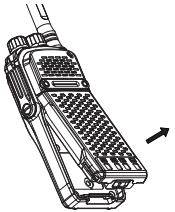

Disassemble: Lift battery catch on bottom of the battery, lift up and pull away from chassis.

Assemble the antenna

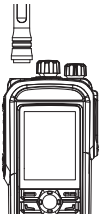

Insert antenna's threaded connector into the radio's antenna connector. Thread clockwise until snug. Do not over tighten.

Assemble the belt clip

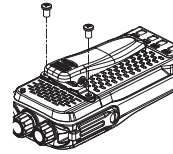

Assemble: Attach belt clip using the provided screws by aligning screws with threaded holes in chassis.

Disassemble the belt clip

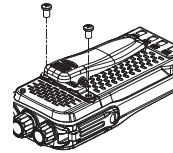

Disassemble: Unscrew the screws holding the the belt clip and remove belt clip from chassis.

Insert the earphone

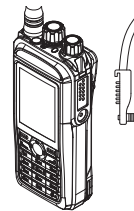

Open the rubber cover to insert the Earphone.

Function key

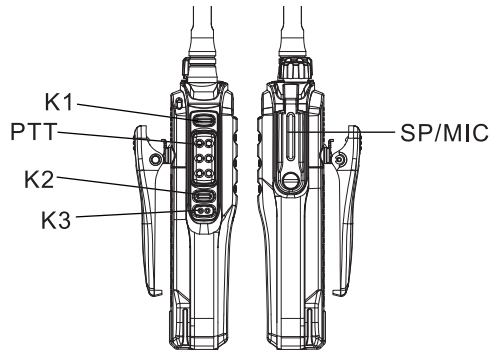
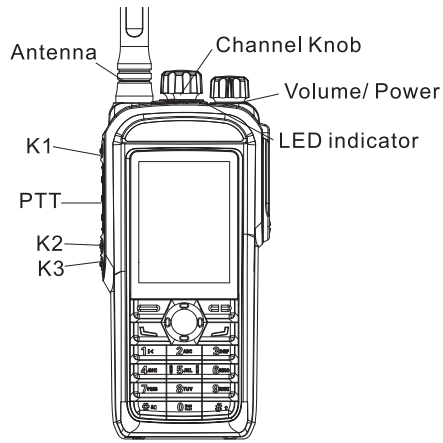

Charging the Battery

Use only the charger and battery specified by Delta. Charger LED can indicate the charging process.

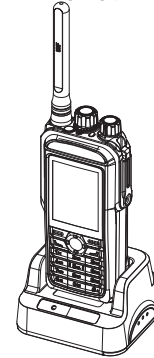

Charger Indicator

Indicator	Charge Status
Red flash	Standby
Red glows	Charging
Green glows	Fully charged

LED Indicator of Transceiver

Indicator	charge Status
Green glows 2-3S	Power-on cycle
Green glows	receiving signal
Green flash	received
Red glows	transmitting
Red flash	Battery low will be indicated by the red LED flashing and an audible beep. Please charge or replace the battery as soon as possible to ensure normal operation.

LCD icon

Icon Name	icon Display	Status Description
VOX		Voice operated function
Emergency alarm icon		The radio is in an emergency alarm state or receives an emergency alarm.
Battery power icon		Display remaining battery power
Transmitting indicator icon		The radio is transmitting
Signal indicator icon		The radio is receiving signal
		No signal
Transmit power icon	L	Current channel power is low power
	H	Current channel power is high power
Speaker icon		Squelch and speaker turned on
Monitor icon		has enabled monitoring
Scan icon		The radio is in the scan state
Lock icon		keyboard locked
Off-network icon		The off-network function is turned on [some radios do not have this function]
Signaling icon	CT	CT has been set to transmit or receive QT
	DN	DN has been set to transmit or receive DQTN
	DI	DI has been set to transmit or receive DQTI

Power on and off

Use only the charger and battery specified by Delta. Charger LED can indicate the charging process.

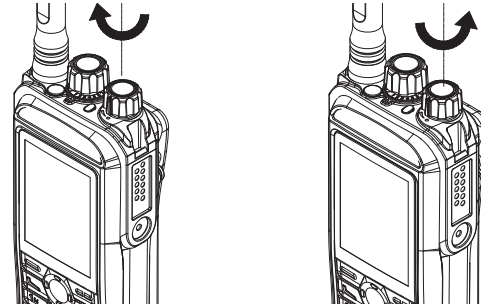

Charger Indicator

Indicator	Charge Status
Red flash	Standby
Red glows	Charging
Green glows	Fully charged

LED Indicator of Transceiver

Indicator	charge Status
Green glows 2-3S	starting up
Green glows	receiving signal
Green flash	received
Red glows	transmitting
Red flash	Battery low, will be issued a low battery beep, please charge or replace the battery as soon as possible to ensure that the product to maintain normal work.

Product operation instructions

Keyboard Introduction

The DS580 has four keyboard modes: frequency mode, channel number mode, DTMF mode, and call ID. Users can select different keyboard modes according to their needs, thus achieving simple and fast operation.

- **Frequency mode:** After the user selects the frequency mode, the frequency of the Radio can be written through the keyboard.
- **Channel number mode:** After the user selects the channel number mode, the required channel number can be directly written through the keyboard, and the Radio automatically jumps to this channel.
- **DTMF mode:** After the user selects DTMF mode, the user can input DTMF code through the keyboard.
- **Call ID:** After the user selects the call ID, the user can input a user ID number through the keyboard and then directly call the other party.

Working mode

The DS580 has three operating modes: Computer mode, debug mode, and user mode. Each mode is entered in a different way.

Entry conditions for each mode:

Mode Type	Button Description
Computer mode	Connect to Computer with write USB cable
Debug mode	Enter the debug mode by CPS(the CPS determines whether to enter)
User mode	Automatically enters user mode when powered on.

Computer mode

After booting, the Computer software is used to control the Radio to enter the Computer mode. In the Computer mode, only the read/write and debugging operations can be performed. The contents displayed on the LCD are as follows: "PC LINK"

Read From Radio

During reading, a progress bar shows the reading process "reading ", the red light flashes When this process is finished, a "Read Successfully" window appears. The reading error display content: the middle "reading error", the orange light flashes, and there is beep.

Write To Radio

During reading, a progress bar shows the reading process " Writing... ", the red light flashes When this process is finished, a " Write Successfully" window appears. The reading error display content: the middle " Writing error", the orange light flashes, and there is beep.

User Mode

1. Power ON/OFF

Power on: Turn the [Power Switch/Volume Control Knob] clockwise to hear the "K" sound, the Radio is turned on, and if the power-on prompt tone is set, a power-on tone will be sounded to display the boot LOGO. The display mode will differ based on selection as shown below.

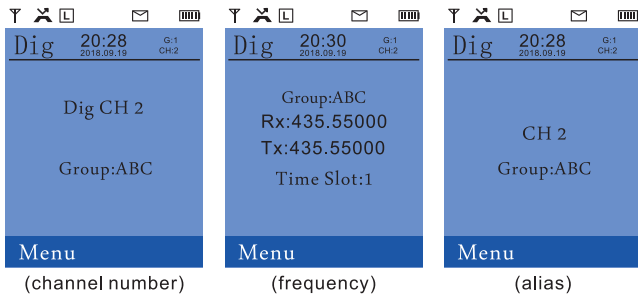

Once powered on radio will enter the receive state.

Shutdown: Turn the Power Switch / Volume Control counter-clockwise until it clicks. An audible beep will sound and the display will show the shutdown screen.

2. Switching channels

To switch channels, rotate the Channel Knob or using the keyboard mode for channel set, input the desired channel number. If the voice announcement is enabled then the channel number will be announced. The LCD will display the channel information based on the selected display mode. The display mode selection is shown in Figure 1 as the channel number; the channel mode is selected as the frequency shown

in Figure 2; and the channel mode selection as the alias is shown in Figure 3.

Figure:

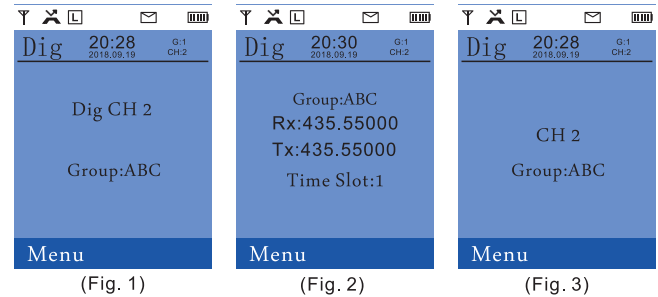

3. Call operation

Transmitting: Press and hold the PTT button, the mouth is 3-5CM away from the MIC position, speaking to the MIC. screen display



Receiving: When the carrier is received,  displayed. If no signaling or signaling is correct, the speaker emits sound. Adjust the volume knob to change the sound level as required. Note:

If the LED is on, but no sound is emitted, it may be incorrect signaling (such as CTCSS, DCS, color code, ID, etc.)

4. Programmable function key function

There are 4 programmable buttons, the function of which can be defined by software, called programmable button (K1, K2, K3, TK button). Programmable buttons can be modified by the CPS.

Programmable button function definition list

Button	status	button assignment function
K1 K2 K3	Short Press	No function; emergency alarm; cancel emergency alarm; voice control; power switching; steady state monitoring [analog]; transient monitoring [analog]; steady state cancellation squelch [analog]; transient cancellation squelch [analog]; Talk Around; off-line; scan; one-touch call 1 (DMR); one-touch call 2 (DMR); one-touch call 3 (DMR); one-touch call 4 (DMR); broadcast local ID [number]; broadcast channel Number; broadcast power; broadcast battery power;
	Long Press	No function; emergency alarm; cancel emergency alarm; voice control; power switching; steady state monitoring [analog]; transient monitoring [analog]; steady state cancellation squelch [analog]; transient cancellation squelch [analog]; Talk Around; off-line; scan; one-touch call 1 (DMR); one-touch call 2 (DMR); one-touch call 3 (DMR); one-touch call 4 (DMR); broadcast local ID [number]; broadcast channel Number; broadcast power; broadcast battery power; broadcast channel type; serial port report (production version only);

Key function description:

1. No function

No function definition, the button is invalid and there is an error tone.

2. Emergency alarm

Press this button to initiate an emergency alert, which is typically associated with the top orange button. Emergency can only be supported by a short key press. A long key press is associated with emergency off.

3. Cancel emergency alarm

Press this button to terminate an emergency alert, which is typically associated with the top orange button. A long key press is associated with emergency off. Emergency can only be supported by a short key press.

4. VOX

Use this to enable or disable the function VOX.

5. Power switching

Switch high power (H), low power (L) according to the function key programmed as "power switching"

6. Analog Monitor - Continuous

when key is toggled on.

7. Analog Monitor - Temporary

Open squelch in analog when key is depressed.

8. Talk Around

Allows the user when on a selected repeater channel, to press key and talk on the repeaters output frequency. Toggle to return to repeater operation.

9. Scanning

Press this button to turn the scan function on or off
After pressing the programming scan button, there is a "beep" prompt to enter the scan. At this time, it flashes green, and after the button is pressed, it prompts two "beep" to exit the scanning state.

10. One-click call 1~4 (DMR)

Short cut operation for selected features. press the one-touch key to start preprogrammed function followed by PTT.

5.Menu

1.Menu key

Press the menu button to display the main menu interface, press the up and down keys, select the menu, and then press the menu selection button to confirm the selection.

Press the Cancel Back button to return to the previous interface.

2. The main menu contains the menu items in the following figure.

The main menu items can be defined by the CPS.

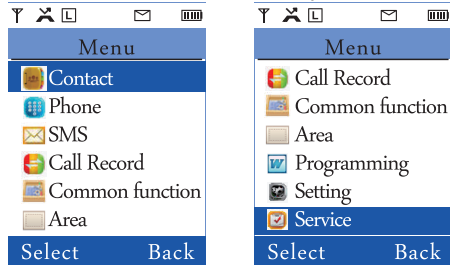

3. The submenus contained in the menu item are as follows:

The submenu can also be set by the CPS. The following is just a rough framework, and the actual submenu may have a slight difference.

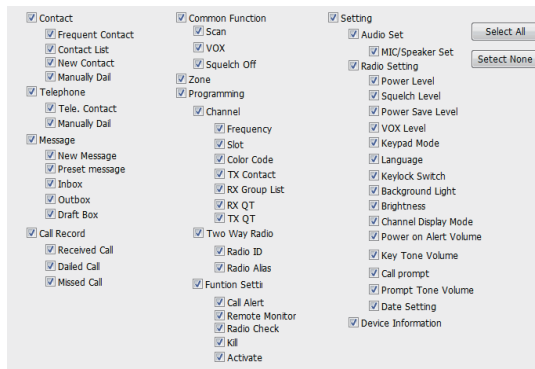

Menu item-- contact: Select whether you can access the contact list through the menu or initiate a call to the contact.

Option Description: Check, uncheck

Check: Users can access the contact list through the menu.

Default: check

Contains child common contacts, contact lists, new contacts, manual dialing

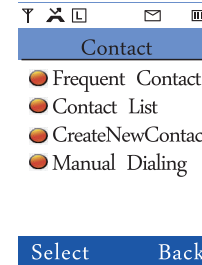

Common Contacts: Set whether to display the “Common Contacts” submenu item in the “Contact” menu of the Radio.

End users can check through this submenu

Look at the "Common Contact List", you can also add, view, and delete frequently used contacts, and send "Supplemental Services" to frequently used contacts.

Option Description: Check, uncheck

Check: The “Common Contacts” menu item is displayed on the Radio interface.

Unchecked: The “Common Contacts” menu item is not displayed on the Radio interface.

Default: check

Contact list: All the set contacts are displayed through the menu.

In this directory, press PTT to directly call the selected contact.

Option Description: Check, uncheck

Check: Show all contact lists.
Unchecked: Do not display the contact list.
Default: check

New Contact: You can choose whether you can create a new contact through the menu. When the selection can be created, enter the contact list and select New Contact.

Add a new contact to the list.

Option Description: Check, uncheck

Check: Users can create new contacts through the menu.

Unchecked: Users cannot create new contacts through the menu.

Default: check

Manual Dialing: You can choose whether you can access the manual dialing function through the menu, that is, the user can enter the

ID of the target by the panel key to initiate a call.

Option Description: Check, uncheck

Check: Users can enter the manual dialing function through the menu.

Unchecked: The user cannot activate the manual dialing function through the menu.

Default: check

Phone: Select whether you can access the phone function through the menu.

Option Description: Check, uncheck

Check: Users can access the phone function through the menu.

Unchecked: Users cannot access the phone function through the menu.

Default: check

Contains Subitem, phone contacts, manual dialing

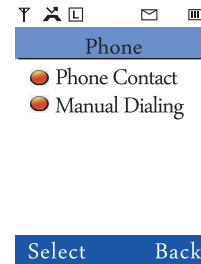

Short Message: Text message and quick text message service that allows these messages to be sent between users.

Users can edit messages to be launched or stored in the main In the machine, you can also receive text messages from other users.

Check: Users can access the information function through the menu.

Contains sub-items new short message, shortcut text, inbox, outbox, draft box

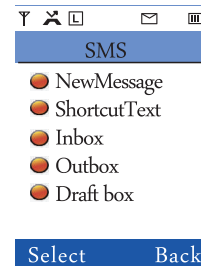

New Message: Select this option to create a new message.

Each message can contain up to 256 characters.

New information can be sent or saved on the host.

Check: Users can create new text information from the menu.

Unchecked: Users cannot create new text messages from the menu.
Default: check

Quick Text: A predefined message may be created within CPS and stored in the radio. Up to 25 can be stored for recall, when the user creates a new letter

Check: Users can access text information from the menu.
Unchecked: Users cannot access text information from the menu.
Default: check

Inbox: A receiving radio may automatically save up to 20 messages received. The user may review, edit, and forward. Users can edit this information or forward it through the menu.
Check: Users can access the outbox to view text information from the menu.
Unchecked: Users cannot access the Inbox from the menu.
Default: check

Outbox: A radio may automatically save up to 20 messages created locally. The user may review, edit, and forward.
Check: Users can view or send text messages from the menu access to the Outbox.
Unchecked: Users cannot access the Outbox from the menu.
Default: check

Drafts: A user may save up to 20 draft text messages before sending them. They may be accessed, edited or sent as needed.
Check: Users can access drafts from the menu to edit or send text messages.

Unchecked: Users cannot access drafts from the menu.
Default: check

Call Record: Allows user to view record of calls sent, answered, and received.
Check: Users can view the call log through the menu.
Default: check
Contains child received calls, placed calls, missed calls

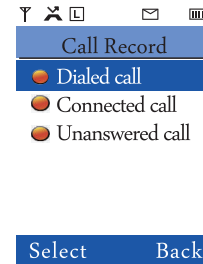

Received call: After selecting this option, the user can view the received call records from the menu (up to the latest 10 records can be stored) and can initiate call.
Check: Users can view the received call records from the menu.
Unchecked: Users cannot view a call record from the menu.
Default: check

Dialed call: After selecting this option, the user can view the outgoing call record from the menu (up to the latest 10 records can be stored) and can initiate call.
Check: Users can view the dialed call history from the menu.
Unchecked: Users cannot view the dialed call history from the menu.
Default: check

Missed Calls: User can view up to 10 unacknowledged calls and initiate a return call without using the contact list.
Check: Users can view from the menu to the missed call record.
Unchecked: Users cannot view missed call records from the menu.
Default: check

Channel:This parameter allows you to configure whether the Channel option will be available in the radio's menu . It contains:
Checked: The Channel option will be available in the radio's menu.
Default :Unchecked

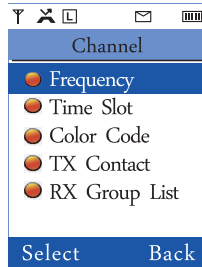

Frequency:This parameter allows you to configure whether the Frequency option will be available in the radio's menu. If you have checked it, the user may modify frequency via the menu.
Checked: The Frequency option will be available in the radio's menu.
Unchecked: The Frequency option will be unavailable in the radio's menu.
Default :Unchecked

Slot:This parameter allows you to configure whether the Slot option will be available in the radio's menu . If you have checked it, the user can modify the slot for transmission and receiving on the current digital channel. For details, please refer to the use of the parameter .
Checked: The **Slot** option will be available in the radio's menu.
Unchecked: The **Slot** option will be unavailable in the radio's menu.
Default :Unchecked

Color Code :This parameter allows you to configure whether the Color Code will be available in the radio's menu . If you have checked it, the user can modify the value of the color code of the current digital channel. For details please refer to the use of the parameter.
Checked: The Color Code option will be available in the radio's menu.
Unchecked: The Color Code option will be unavailable in the radio's menu.
Default :Unchecked

CTCSS/CDCSS:This parameter allows you to configure whether the CTCSS/CDCSS option will be available in the radio's menu . If checked, the user can modify the current signaling on the analog channel via the menu.
Checked: The TX CTCSSCDCSS and RX CTCSSCDCSS options will be displayed in the radio interface.
Unchecked: The TX CTCSSCDCSS and RX CTCSSCDCSS options will not be displayed in the radio interface.
Default :Unchecked

Tx Contact Name: This parameter allows you to configure whether the Tx Contact Name option will be available in the radio's menu . If checked, the user can modify the current digital channel via the menu.

Checked: The Tx Contact Name option will be available in the radio's menu.

Unchecked: The Tx Contact Name option will be unavailable in the radio's menu.

Default :Unchecked

Rx Group List: This parameter allows you to configure whether the Rx Group List will be available in the radio's menu .

If checked, the user can modify the current digital channel via the menu.

Checked: The Rx Group List option will be available in the radio's menu.

Unchecked: The Rx Group List option will be unavailable in the radio's menu.

Default :Unchecked

Channel Alias: This parameter allows you to set whether the "Channel Alias" option is included on the radio menu. If included, radio user can modify the channel alias through radio menu.

Checked: The Channel Alias option is included on the radio menu.

Unchecked: The Channel Alias option is not included on the radio menu.

Default :Unchecked

Note : This parameter is available only when "channel" parameter is selected.

Safety information



This manual provides you with safety instructions for the **DELTA** portable two-way radio.

Operation and Electromagnetic Exposure

Press PTT, hold the radio in a vertical position from 2.5 to 5.0 cm (1 to 2 inches) away from lips. Insure that the antenna is at least 2.5 cm away from your head and body when transmitting.

Electromagnetic Interference (EMI) / Electromagnetic Compatibly (EMC)

All electronic devices are subject to and may be affected by EMI unless proper compatibility design and testing have been accomplished. Radios should be powered off if unsure of EMI / EMC effects. Radios should be powered off aboard aircraft and the user shall adhere to the any and all airline requirements for RF emitters.

Operation warning

Radios including mobiles and portables shall not be mounted permanently or temporarily in areas of vehicles that use air bag safety restraint systems. Placing devices on or near air bags during deployment pose a safety hazard to the occupants of the vehicle.

Environment with explosion risk

Radios shall be powered off when in environments that pose an explosion risk unless the radio has received FM or Cenelec approval with certificate. In such environments, a small spark may lead to an explosion, fire, damage and death.

In the blast area or area with detonator

Radios shall be powered off near to and within an blasting area where detonators or other explosive materials are in use or stored.



Operation instruction

Damaged antenna

Damaged antennas shall be replaced. Exposure to the metallic portions of a damaged antenna can lead to burns.

Battery

Batteries shall not be changed or charged in explosive risk environments. Minor flames and / or sparks can lead to a explosion.

Any metal conductor, such as jewelry or keys, touching the battery contacts may lead to a short circuit condition that may result in a fire or burn. Care should be exercised to insure that the battery contacts are not allowed to touch other objects.

Radio's maintainance

- 1.Chemicals such as alcohol, cleaning fluids, and petroleum based products will damage the radio surfaces.
- 2.Do not pick up the radio using the antenna or purposely stress the housing and belt clip.
- 3.Please close the dust proof cover to protect the Microphone/ speaker jack while not using accessory.
- 4.Clean the surface of the radio with only a damp cloth using water. Insure that none of the water enters the radio case.
- 5.Unrecognized accessories may damage the radio and in this case our warranty will be unavailable.

Technical Specification

General Specification

Frequency Range UHF : **450-520 MHz**

Modulation Type: Analog: FM Digital: 4FSK

Channel Separation: Analog: 12.5kHz, 20kHz, 25kHz
Digital: 12.5kHz

Rated Output Power: 4W

Engineering personnel setting up those frequency ranges with Customer Programming Software(CSP), the mechanism implemented in the product to avoid the end user to managing changes in the definition of operating frequency ranges in order to avoid usage of un-allowed frequency ranges.